

ctesi | É UMA CASA DE BANHO
PORTUGUESA, COM CERTEZA!

Clean & Safe

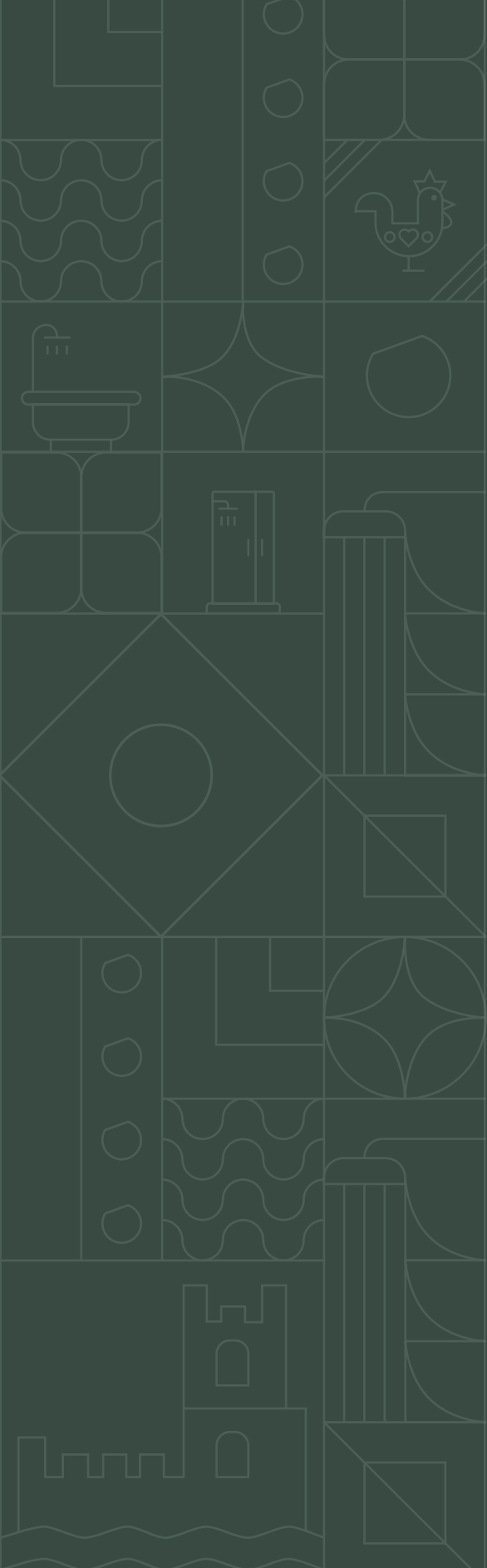

www.ctesi.pt



ctesi

Clean & Safe

Esta gama foi pensada especialmente para pessoas com mobilidade reduzida. Caracterizado pelo seu cuidado em termos de ergonomia, estabilidade e conforto. Os produtos são projetados para que sejam duráveis, mas confortáveis para o uso diário dos espaços de banho inclusivos.

Gama especialmente diseñada para personas con movilidad reducida. Caracterizado por su contribución a términos de ergonomía, estabilidad, fiabilidad y confort. Los productos están pensados para ser duraderos, pero cómodos en el uso diario de espacios de baño inclusivos.



空手道

MUSEE D'ART MODERNE DE LA BIENNE DE PARIS

YAYOI KUSAMA

剣道

TOKYO

cheer

cheer



8

SUPORTES / LAVATÓRIO
SOPORTES / LAVABO



9

SANITA COMPACTA HANDICAP
INODORO COMPACTO HANDICAP



10

SECADOR DE MÃOS / FRALDÁRIOS
SECADORA DE MANOS / CAMBIA PAÑALES



12

PAPELEIRAS
PAPELERAS



14

BARRAS DE APOIO
BARRAS DE APOYO



16

DISPENSADORES DE SABÃO/ GEL
DISPENSADORES DE JABÓN/GEL



17

TORNEIRAS
GRIFOS



20

TOALHEIROS E ACESSÓRIOS
TOALLEROS Y ACCESORIOS DE BAÑO



21

GAMA HOTEL



28

TORNEIRAS ELETRÓNICAS
GRIFOS ELECTRÓNICOS



30

TORNEIRAS TEMPORIZADAS
GRIFOS TEMPORIZADOS



32

FLUXOMETRO
FLUJÓMETRO



33

TORNEIRAS TEMPORIZADAS PEDAL
GRIFOS TEMPORIZADOS



36

CABINES DE DUCHE
MAMPARAS DE DUCHA

Handi capped

As barras de apoio, fixas ou rebatíveis, são fundamentais para a acessibilidade e a segurança na casa de banho, especialmente para pessoas com mobilidade reduzida, idosos e pessoas com deficiências físicas.

Certificação Barras de Apoio Ø35 mm.
Produto testado e aprovado por laboratório certificado em conformidade com o DL 163/2006.

As barras de apoio, fixas ou rebatíveis, são fundamentais para a acessibilidade e a segurança na casa de banho, especialmente para pessoas com mobilidade reduzida, idosos e pessoas com deficiências físicas.

Certificación de barras de apoyo Ø35 mm
Probado y aprobado por laboratorio certificado en de conformidad con el DL 163/2006.

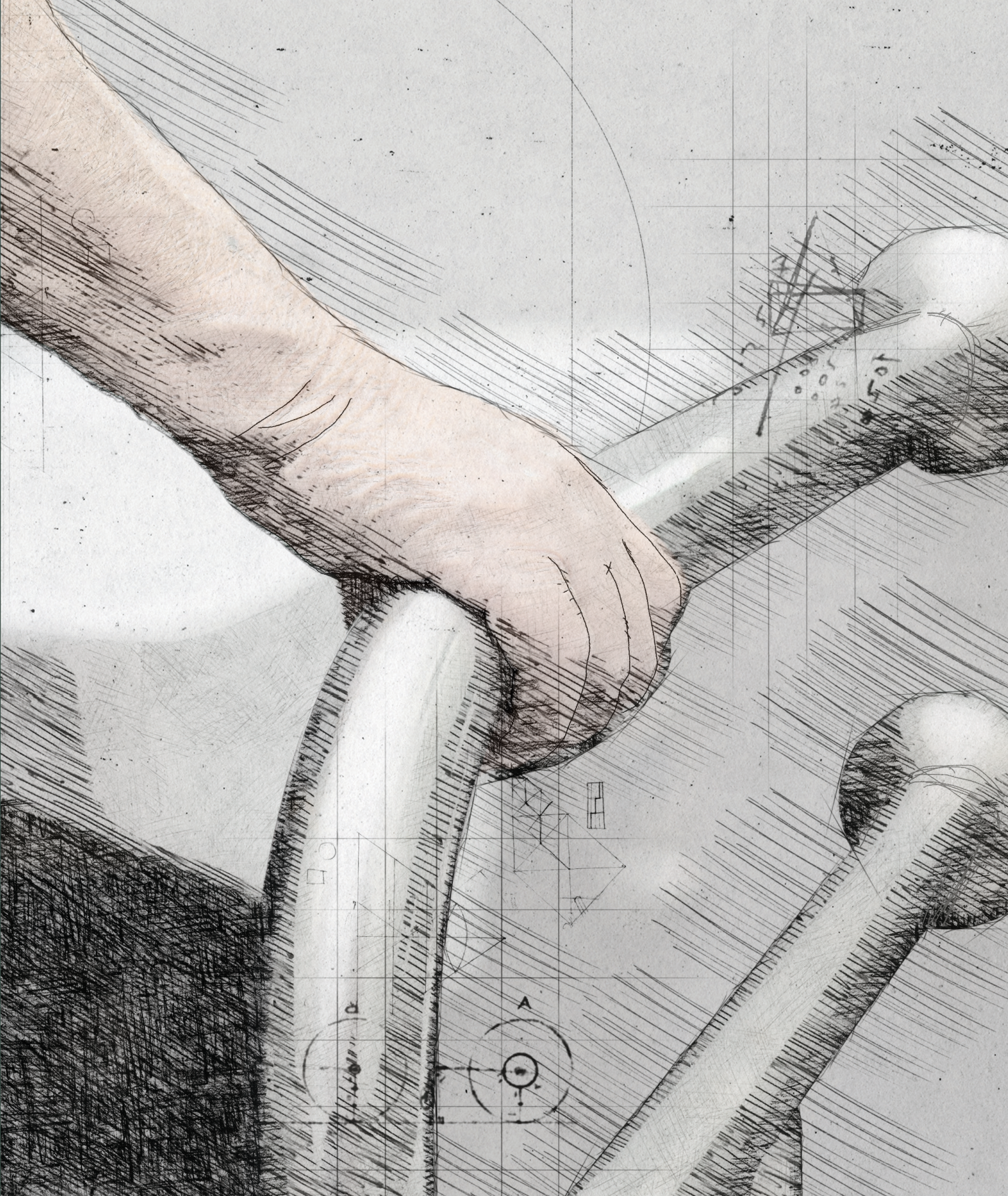



1 Suporte de lavatório
soporte lavabo

194,00€

● BL7502305



2 Suporte de lavatório basculante
soporte lavabo basculante

379,00€

● BL7502306



3 Lavatório handicap
lavabo handicap

246,00€

● BL7502300

4 Espelho reclinável
espejo basculante

238,00€

● CT1205155

AISI 304 AJUSTE MANUAL
AJUSTE MANUAL

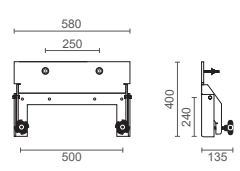

1

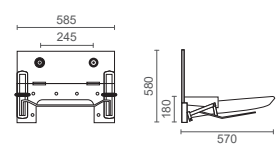

2

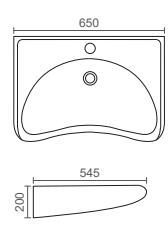

3

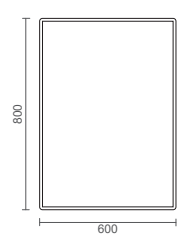

4



Sanita compacta Handicap
inodoro compacto Handicap

As sanitas adaptadas Handicap são desenvolvidas para serem acessíveis e seguras para pessoas com mobilidade reduzida ou outras necessidades especiais.

Los inodoros adaptados Handicap están diseñados para ser accesibles y seguros para personas con movilidad reducida u otras necesidades especiales.

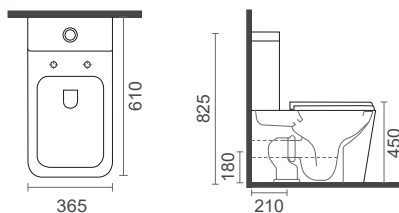

DESCARGA AO CHÃO
SALIDA A SUELO

TAMPO DUROPLAST
TAPA INODORO DUROPLAST

360,00€

● BL7502340



SISTEMA Spiral Flush

O sistema de descarga SPIRAL FLUSH da Ctesi oferece muito mais do que uma limpeza eficaz da sanita! É também um sistema silencioso que maximiza a eficiência na poupança de água.

¡El sistema SPIRAL FLUSH de Ctesi ofrece mucho más que una limpieza efectiva del inodoro!

También es un sistema silencioso que maximiza la eficiencia en el ahorro de agua.



Em conformidade com o DL 163/2006
En conformidad con el DL 163/2006.



1 WIND
Secador de mãos
secadora de mãos

674,00€

- CT1205871
- CT1205870 624,00€

⚡ 1750 W CLASSE I IP23 ABS



2 HD1350
Secador de mãos
secadora de mãos

242,00€

- CT1205842
- CT1205843 242,00€
- CT1205844 242,00€

AISI 304 ⚡ 1350 W CLASSE I IP23



3 Fraldário vertical
cambia pañales vertical

544,00€

- CT1205905

DE ACORDO C/ NORMA EN 12221
CUMPLE LA NORMA EN 12221



4 Fraldário horizontal
cambia pañales horizontal

544,00€

- CT1205900

DE ACORDO C/ NORMA EN 12221
CUMPLE LA NORMA EN 12221

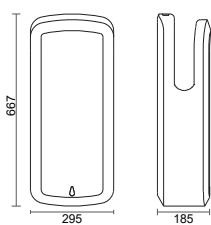

1

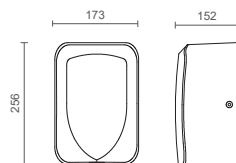

2

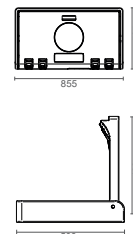

3

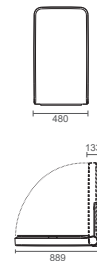

4



Secador de mãos HD1350
secador de manos HD1350



1

DT400
Dispensador de papel
distribuidor de papel

67,50€

● CT1205400

■ 400 FOLHAS | 400 HOJAS

AISI 304



2

DJI JUMBO
Dispensador de papel
distribuidor de papel

64,50€

● CT1205300

AISI 304

● Ø220 mm



3

Papeleira de parede
papelera de baño - pared

108,60€

● CT1205550

AISI 304

25L

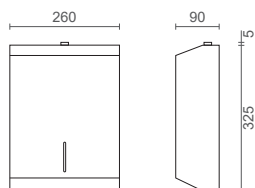

1

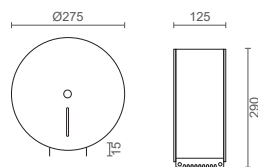

2

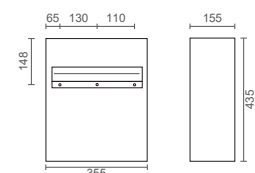

3

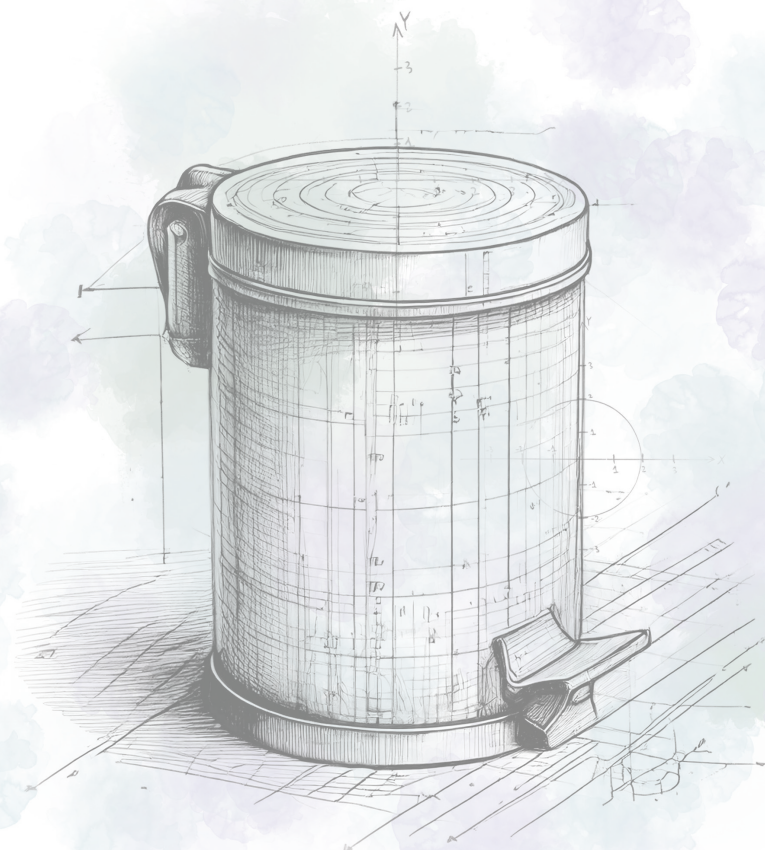

SOFT-CLOSE



4 **Papeleira**
papelera de baño

28,90€

- 3L CT1205500
- 5L CT1205502 34,10€
- 12L CT1205504 51,60€
- 5L CT1205540 44,30€

AISI 304

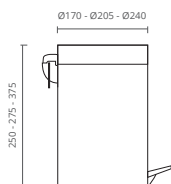

4

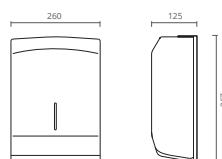

5



5 **DT600**
Dispensador de papel
distribuidor de papel

29,80€

● CT1205440

600 FOLHAS | 600 HOJAS

ABS BRANCO
ABS BLANCO



6 **DJN JUMBO**
Dispensador de papel
distribuidor de papel

25,10€

● CT1205340

Ø220 mm ABS BRANCO
ABS BLANCO

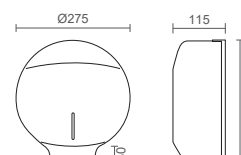

6



1 Barra de apoio
barra de apoio

47,00€

300	CT1205000	
400	CT1205002	51,90€
500	CT1205004	57,80€
600	CT1205006	62,70€
800	CT1205008	73,40€

AISI 304



2 Barra de apoio 135°
barra de apoio 135°

71,20€

CT1205010

AISI 304



3 Barra de apoio 90°
barra de apoio 90°

71,20€

CT1205015

AISI 304



4 Barra de apoio com 3 apoios
barra de apoio con 3 anclajes

142,70€



600

DIREITA
DERECHA CT1205030

ESQUERDA
IZQUIERDA CT1205031

AISI 304

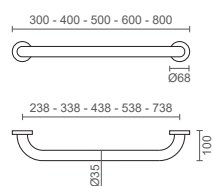

1

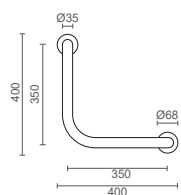

2

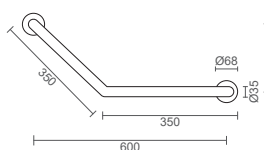

3

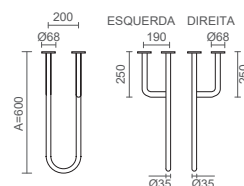

4

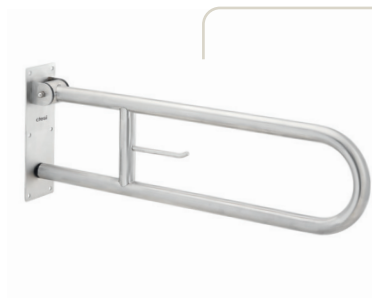

5

Barra de apoio rebatível com porta rolo
barra de apoio abatible con portarrollos

146,10€

800

CT1205060

AISI 304

6

Barra de apoio rebatível
barra de apoyo abatible

146,10€

800

CT1205061

AISI 304



7

Banco de duche rebatível
asiento de ducha abatible

247,10€

CT1205105

AISI 304

120 kg

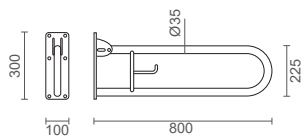

5

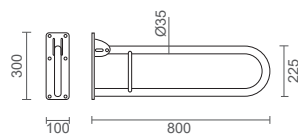

6

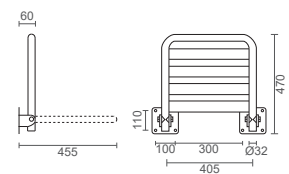

7



1

DSV 12 - 1100ML
 Dispensador de sabão vertical
 dispensador de jabón vertical

DEPÓSITO INTERIOR PLÁSTICO (ANTI-CORROSÃO)
 DEPÓSITO INTERIOR DE PLÁSTICO (ANTICORROSIÓN)

44,50€

● CT1205200



2

DSH 12 - 1100ML
 Dispensador de sabão horizontal
 dispensador de jabón horizontal

DEPÓSITO INTERIOR PLÁSTICO (ANTI-CORROSÃO)
 DEPÓSITO INTERIOR DE PLÁSTICO (ANTICORROSIÓN)

50,20€

● CT1205210



4

Dispensador de cotovelo 1000ml
 dispensador del codo 1000ml

48,80€

● CT1205281



3

Dispensador automático 1100ml
 dispensador automático 1100ml

CIRCUITO DIGITAL COM SENSOR DE INFRAVERMELHOS
 CONTROL DE CIRCUITO DIGITAL CON SENSOR INFRARROJO

84,20€

●

SABÃO/GEL CT1205250
 JABÓN/GEL

SPRAY CT1205251
 SPRAY

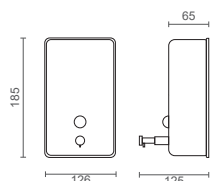

1

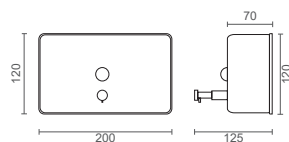

2

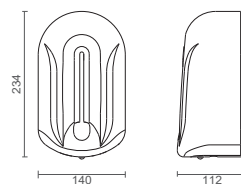

3

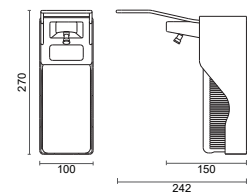

4



5 **DOC**
Monocomando lavatório
Monomando lavabo

106,80€

CT2006700

6 **DOC**
Monocomando duche
Monomando ducha

147,60€

CT2006730

KIT ACESSÓRIO ABS + BICHA CROMADA
SET ACCESORIOS EN ABS + FLEXIBLE



7 **Dispensador automático de balcão**
dispensador automatico de balcón

18,00€

CT1205255

350 ml



8 **TEMPORIZADA DE DUCHE**
Duche parede
ducha-pared

113,60€

CT5050350

TEMPORIZADO
TEMPORIZADO

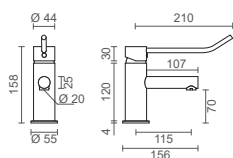

5

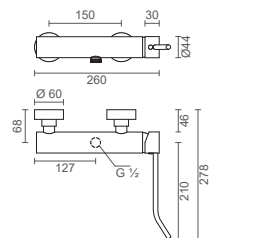

6

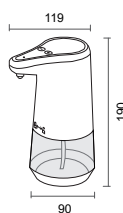

7

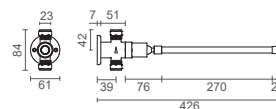

8



Toalheiros & Acessórios

Os toalheiros são um elemento que acrescenta arrumação ao seu espaço de banho. Com linhas simples e um design eficiente, são adaptáveis aos diferentes estilos e ambientes de banho. Escolha o modelo do seu toalheiro e torne o seu espaço de banho mais agradável.

Los toalleros son un elemento que le da más organización a tu baño. Con líneas simples y un diseño eficiente, se adaptan a diferentes estilos y ambientes de baño.

Elige el modelo de tu toallero y haz que tu espacio de baño sea más agradable.

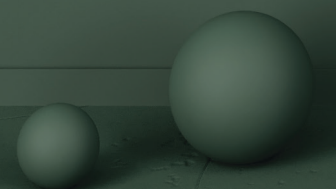



cresci

Dory



1 Toalheiro
Toallero

44,50€

450 CT1310000

600 CT1310100 52,80 €

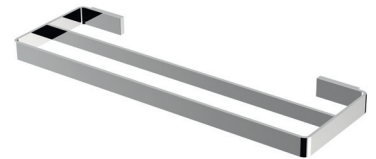

2 Toalheiro duplo
Toallero doble

79,80€

600

CT1310300

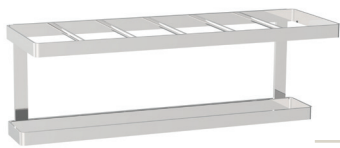

3 Porta toalhas
Toallero

148,80€

CT1310400

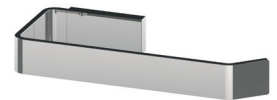

4 Porta rolos
portarollos

24,90€

CT1310500

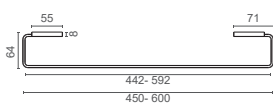

1

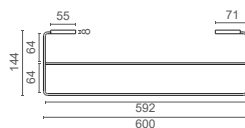

2

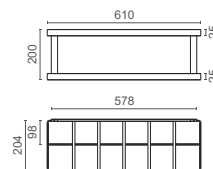

3

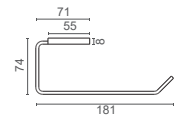

4

5

Porta rolos c/ suporte para smartphone
portarollos con soporte para smartphone

27,30€

● CT1310600



6

Saboneteira retangular
jabonera rectangular

42,40€

● CT1310900



7

Cabide
percha

11,90€

● CT1311200



8

Saboneteira de canto
jabonera de esquina

38,10€

● CT1311000

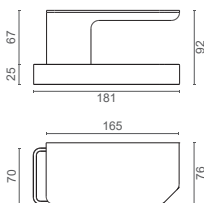

5

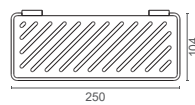

6

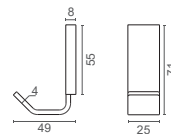

7

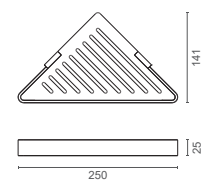

8



Hotel



1 Espelho telescópico
espejo telescópico

64,10€

CT1205160

COM AUMENTO IX / 5X | CON AUMENTO IX / 5X



2 SC1800
Secador de cabelo
secador de pelo

82,20€

CT1205820

1800 W CLASSE II IPX0



3 Piaçaba
escobillero

39,40€

A CHÃO SUELO CT1202460

B PAREDE PARED CT1202465 47,40€

AISI 304

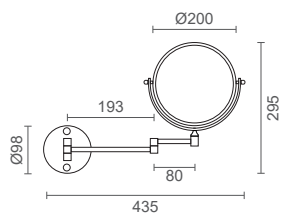

1

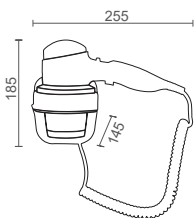

2

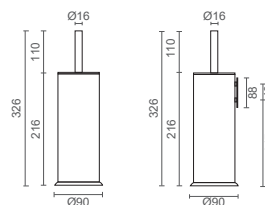

3

4 Barra de apoio
barra de apoyo

38,50€



cm

30 CT1202500

40 CT1202600 41,50€

50 CT1202700 45,50€

AISI 304



5 Barra de apoio com ângulo
barra de apoyo angular

63,50€



CT1202650

AISI 304



6 Porta rolos simples
portarrollos

26,30€



CT1205620

AISI 304

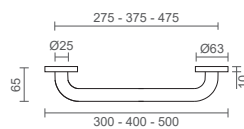

4

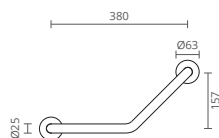

5

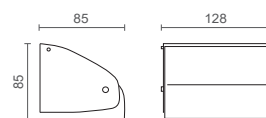

6





Torneiras & eletrónicas & temporizadas

A Ctesi GREEN é a contribuição da Ctesi para um planeta mais sustentável. A Ctesi tem uma preocupação profunda com a água. Sem esforço e com todo o conforto, opte por torneiras com cartuchos economizadores ou torneiras temporizadas, para uma utilização racionalizada da água em sua casa ou em espaços públicos.

Ctesi GREEN es la contribución de Ctesi a un planeta más sostenible. Ctesi está profundamente preocupado por el agua. Sin esfuerzo y cómodamente, elija grifos con ahorradores de cartucho o grifos temporizados para un uso racionalizado del agua en su hogar o espacios públicos.







cada

gota

conta!

Pequenas ações, grandes economias.

Cada gota cuenta.
Pequeñas acciones, grandes ahorros.

Economia de água

durante a lavagem das mãos em comparação com o uso de uma torneira convencional

Ahorro de agua al lavarse las manos en comparación con el uso de un grifo convencional

torneira clássica



10
l/min*

torneira temporizada



3
l/min*
aberta | abierta

torneira eletrónica



1
l/min*
aberta | abierta

As torneiras temporizadas e eletrónicas reduzem o desperdício, garantindo um uso eficiente da água. Com fecho automático, evita desperdícios e promovem economia sustentável.

Los grifos temporizados y electrónicos reducen el desperdicio, garantizando un uso eficiente del agua. Con apagado automático, evitan derroches y promueven el ahorro sostenible.

* Valores aproximados



1

INSIDE
Torneira eletrónica de encastrar para lavatório
grifo eletrónico empotrado para lavabo

187,30€

1 ÁGUA
1 AGUA CT2300061

2 ÁGUAS
2 AGUAS CT2300060 232,30€

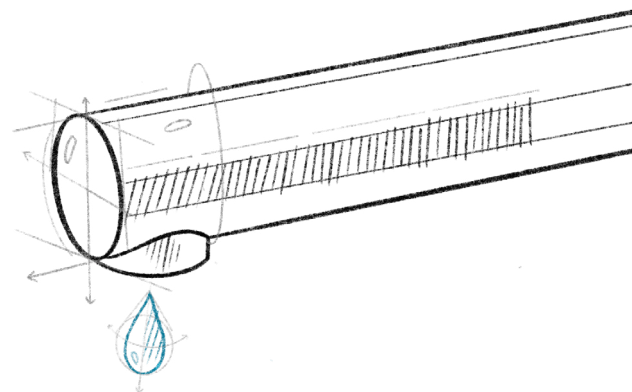

2

BLOK
Torneira eletrónica de encastrar p/ lavatório
grifo eletrónico empotrado para lavabo

198,00€

1 ÁGUA
1 AGUA CT2300051

2 ÁGUAS
2 AGUAS CT2300050 243,00€



3

PIXEL
Torneira eletrónica para lavatório
grifo eletrónico para lavabo

179,60€

1 ÁGUA
1 AGUA CT2300300

2 ÁGUAS
2 AGUAS CT2300305 224,60€



4

SELF
Torneira eletrónica para lavatório
grifo eletrónico para lavabo

148,60€

1 ÁGUA
1 AGUA CT2300075

2 ÁGUAS
2 AGUAS CT2300076 193,60€

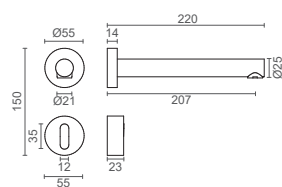

1

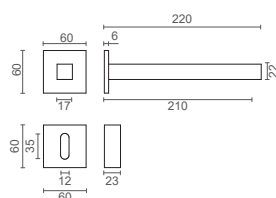

2

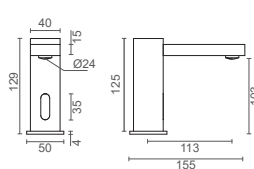

3

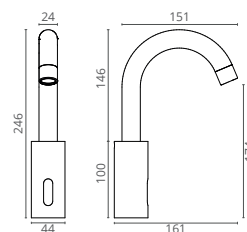

4



5

KEEN
Torneira eletrónica para lavatório alto
grifo electrónico para lavabo alto

248,80€



1 ÁGUA
1 AGUA CT2300080

2 ÁGUAS
2 AGUAS CT2300081 293,80€



6

KEEN
Torneira eletrónica para lavatório
grifo electrónico para lavabo

158,80€



1 ÁGUA
1 AGUA CT2300070

2 ÁGUAS
2 AGUAS CT2300071 203,80€



7

Torneira urinol eletrónica
grifo electrónico de urinario

332,50€



CT2300100

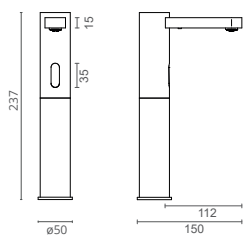

5

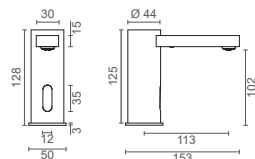

6

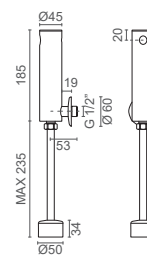

7



1 **LINE**
Torneira lavatório
grifo de lavabo

96,30€

CT5050000



2 **LINE MIX**
Torneira misturadora lavatório
grifo mezclador de lavabo

136,10€

CT5050005



3 **PLUS**
Torneira lavatório
grifo de lavabo

48,10€

CT5050002

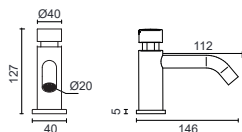

1

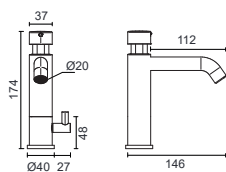

2

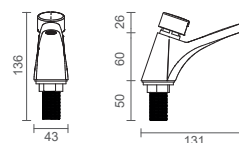

3



4 Torneira branca
grifo mural

66,50€

CT5050010

TORNEIRA 1/2"
GRIFO 1/2"



5 Torneira urinol
grifo urinol

58,50€



SIMPLES CT5050080

C/ ENLACE C/ CONEXIÓN CT5050081 78,50€

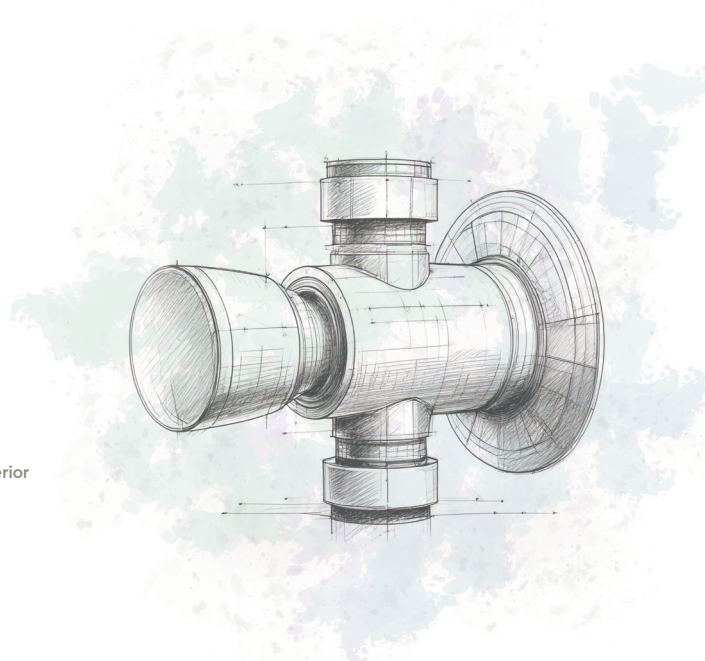

6 Torneira duche exterior
grifo ducha exterior

91,70€

CT5050050

1 ÁGUA
1 ÁGUA



7 Chuveiro anti-vândalo
rociador de ducha antivandálico

75,10€



CT5050045

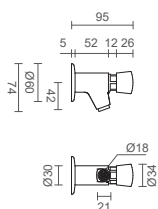

4

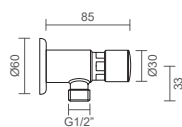

5

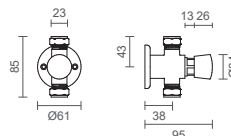

6

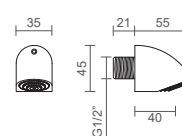

7

1 Fluxómetro temporizados sanita exterior
 flujómetro temporizado exterior

99,80€

CT5050070



2 Tubo para fluxómetro
 tubo para flujómetro

53,50€

CT5050250

A JUSTÁVEL
 AJUSTABLE

3 Bebedouro
 fuente

86,00€

CT5050200

JATO
 CHORRO

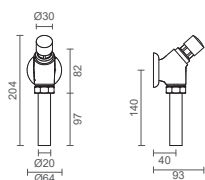
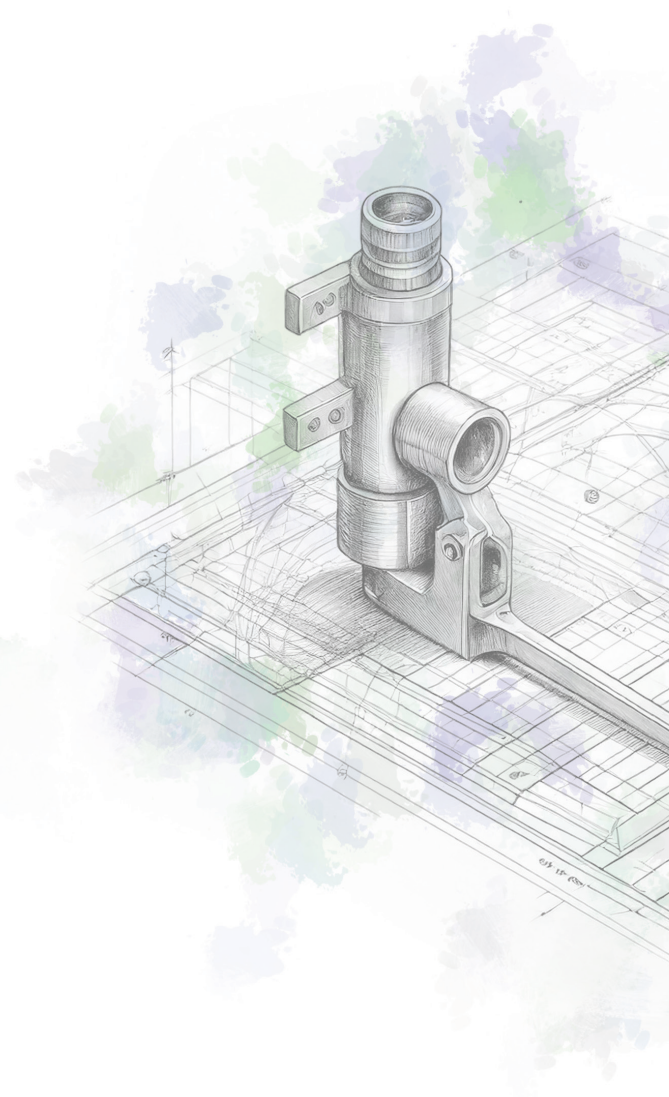

1

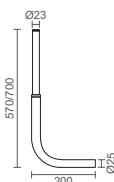

2

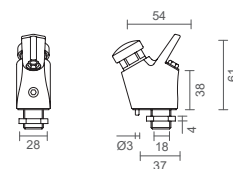

3



5

Temporizada pedal
grifo de pedal temporizado

106,60€

CT5050110

1 ÁGUA
1 ÁGUA

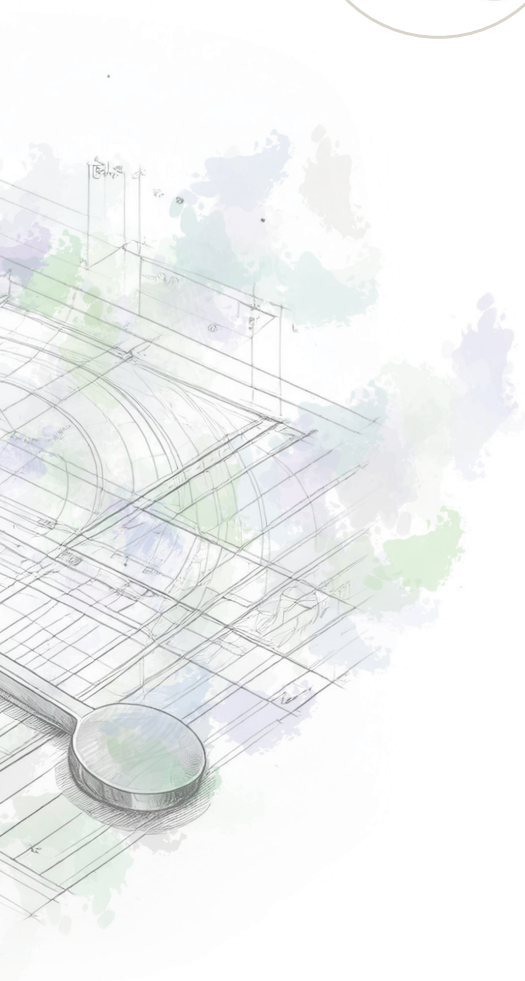

6

Misturadora pedal
mezclador de pedal

120,80€

CT5050115

2 ÁGUAS
2 ÁGUAS

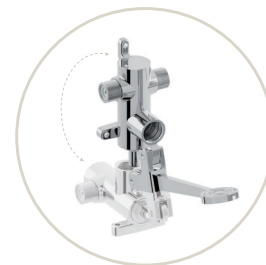

7

Bica
caño

29,50€

CT5050180

TUBO
TUBO

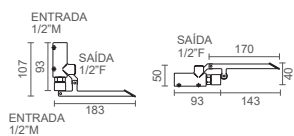

4

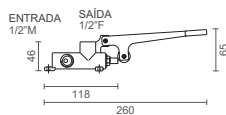

5

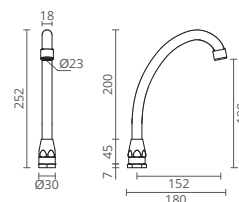

7

Cabines de duche

ACABAMENTOS DE PERFIL | ACABADOS PERFIL

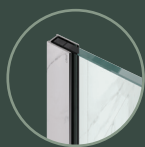

CROMADO
CROMO

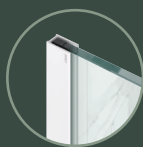

BRANCO MATE
BLANCO MATE

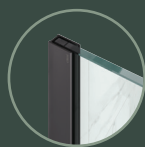

PRETO MATE
NEGRO MATE

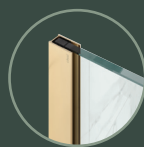

OURO
ORO





CABINE DE DUCHE 2 PORTAS + 1 FIXO
MAMPARA DE DUCHA 2 PUERTAS + 1 FIJO

CM	AJUSTE	ABERTURA APERTURA (+/-1cm)	REF. 		REF. 		REF. 		REF. 	
			REF.	€	REF.	€	REF.	€	REF.	€
70 x 70	68,5 x 70 68,5 x 70	62	DB0713000	700,00 €	DB0723000	700,00 €	DB0733000	810,00 €	DB0743000	865,00 €
75 x 75	73,5 x 75 73,5 x 75	67	DB0713005	720,00 €	DB0723005	720,00 €	DB0733005	830,00 €	DB0743005	885,00 €
80 x 80	78,5 x 80 78,5 x 80	72	DB0713010	730,00 €	DB0723010	730,00 €	DB0733010	840,00 €	DB0743010	895,00 €
90 x 90	88,5 x 90 88,5 x 90	82	DB0713020	770,00 €	DB0723020	770,00 €	DB0733020	880,00 €	DB0743020	935,00 €

PARA MAIOR ESTABILIDADE É RECOMENDADA A UTILIZAÇÃO DE UMA HASTE DE FIXAÇÃO (NÃO INCLUÍDA)
PARA MAYOR ESTABILIDAD SE RECOMIENDA UTILIZAR VARILLA DE FIJACIÓN (NO INCLUIDA)

CABINE DE DUCHE 4 PORTAS
MAMPARA DE DUCHA 4 PUERTAS

CM	AJUSTE	ABERTURA APERTURA (+/-1cm)	REF. 		REF. 		REF. 		REF. 	
			REF.	€	REF.	€	REF.	€	REF.	€
70 x 70	68,5 x 70 68,5 x 70	88	DB0713100	880,00 €	DB0723100	990,00 €	DB0733100	990,00 €	DB0743100	1 045,00 €
75 x 75	73,5 x 75 73,5 x 75	95	DB0713105	900,00 €	DB0723105	1 010,00 €	DB0733105	1 010,00 €	DB0743105	1 065,00 €
80 x 80	78,5 x 80 78,5 x 80	102	DB0713110	920,00 €	DB0723110	1 030,00 €	DB0733110	1 030,00 €	DB0743110	1 085,00 €
90 x 90	88,5 x 90 88,5 x 90	116	DB0713120	950,00 €	DB0723120	1 060,00 €	DB0733120	1 060,00 €	DB0743120	1 115,00 €

FRONTAL DE DUCHE 2 PORTAS
FRONTAL DE DUCHA 2 PUERTAS

CM	AJUSTE	ABERTURA APERTURA (+/-1cm)	REF. 		REF. 		REF. 		REF. 	
			REF.	€	REF.	€	REF.	€	REF.	€
70	68 71	58	DB0713200	535,00 €	DB0723200	615,00 €	DB0733200	615,00 €	DB0743200	655,00 €
75	73 76	63	DB0713205	545,00 €	DB0723205	625,00 €	DB0733205	625,00 €	DB0743205	665,00 €
80	78 81	68	DB0713210	555,00 €	DB0723210	635,00 €	DB0733210	635,00 €	DB0743210	675,00 €
85	83 86	73	DB0713215	560,00 €	DB0723215	640,00 €	DB0733215	640,00 €	DB0743215	680,00 €
90	88 91	78	DB0713220	570,00 €	DB0723220	650,00 €	DB0733220	650,00 €	DB0743220	690,00 €
95	93 96	83	DB0713225	580,00 €	DB0723225	660,00 €	DB0733225	660,00 €	DB0743225	700,00 €
100	98 101	88	DB0713230	590,00 €	DB0723230	670,00 €	DB0733230	670,00 €	DB0743230	710,00 €

FRONTAL DE DUCHE 4 PORTAS
FRONTAL DE DUCHA 4 PUERTAS

CM	AJUSTE	ABERTURA APERTURA (+/-1cm)	REF. 		REF. 		REF. 		REF. 	
			REF.	€	REF.	€	REF.	€	REF.	€
70	68 71	57	DB0713300	720,00 €	DB0723300	800,00 €	DB0733300	800,00 €	DB0743300	840,00 €
75	73 76	62	DB0713305	730,00 €	DB0723305	810,00 €	DB0733305	810,00 €	DB0743305	850,00 €
80	78 81	67	DB0713310	740,00 €	DB0723310	820,00 €	DB0733310	820,00 €	DB0743310	860,00 €
85	83 86	72	DB0713315	750,00 €	DB0723315	830,00 €	DB0733315	830,00 €	DB0743315	870,00 €
90	88 91	77	DB0713320	760,00 €	DB0723320	840,00 €	DB0733320	840,00 €	DB0743320	880,00 €
95	93 96	82	DB0713325	770,00 €	DB0723325	850,00 €	DB0733325	850,00 €	DB0743325	890,00 €
100	98 101	87	DB0713330	780,00 €	DB0723330	860,00 €	DB0733330	860,00 €	DB0743330	900,00 €

OPÇÕES DE VIDRO
OPCIONES DE CRISTAL

MEDIDAS	SERIGRAFADO SERIGRAFIA	FOSCO MATE	GRIS/BRONZE GRIS/BRONCE	IMPRESSÃO DIGITAL SERIGRAFIA PERSONALIZADA	CANELADO ACANALADO
Até 100	+ 30 €	+ 100 €	+ 150 €	+ 250 €	+ 150 €
101 - 200	+ 60 €	+ 200 €	+ 300 €	+ 500 €	+ 300 €
201 - 300	+ 90 €	+ 300 €	+ 450 €	+ 750 €	+ 450 €

VARIAÇÃO DE MEDIDAS | VARIACIÓN DE MEDIDAS

Cada 10 cm (altura / largura) acrescentar
Cada 10 cm (altura / ancho) aumentar 30 € P.V.P.



ESPESSURA DO VIDRO
ESPESOR DEL CRISTAL



VIDROS C/ OUTROS
ACABAMENTOS
CRISTAL CON OTROS
ACABADOS



EASY CLEAN
LIMPIEZA FÁCIL



REVERSÍVEL***
REVERSIBLE***



2 m ALTURA
2 m ALTURA



FECHO
MAGNÉTICO
CIERRE
MAGNETICO



HASTE DE FIXAÇÃO
RECOMENDADA
VARILLA DE FIJACIÓN
RECOMENDADA



MEDIDAS
PERSONALIZÁVEIS
MEDIDAS
PERSONALIZABLES

***Reversível somente
para vidro transparente
***Reversible solo para
vidrio transparente



É UMA CASA
DE BANHO
PORTUGUESA,
COM CERTEZA!

ctesi



Barros & Moreira, SA

Rua Industrial, nº 8
Zon Industrial da Ponte Seca
2510-752 Gaeiras - Óbidos
Portugal

geral@ctesi.pt
www.ctesi.pt
Tel.: (+351) 262 837 230 || Fax: (+351) 262 837 231
Serviço de apoio pós venda **LINHA AZUL 808 203 870**